











-  Sollevatore mobile per carrozzerie
-  Mobil lift for car body shops
-  Mobile Hebebühne für Karosseriewerkstätten
-  Elévateur mobile pour carrossiers
-  Elevador móvil para carrocerías



-  Adatto per essere utilizzato nelle carrozzerie • Dotato di 4 ruote piroettanti che permettono lo spostamento dei veicoli sollevati • Sicurezze oleodinamica con doppio cilindro e valvola di blocco • Bloccaggio bracci automatico
-  Suitable for use in car bodies • Equipped with four wheels that allow the movement of vehicles raised • Safety devices with double hydraulic cylinder and block valve • Automatic arm locking device
-  Geeignet für den Einsatz in Autokarosserien • Ausgestattet mit vier Rädern, die die Bewegung von Fahrzeugen erhoben erlauben • Sicherheitseinrichtungen mit Doppel-Hydraulikzylinder und Ventilblock • Automatische Armarretierung
-  Convient pour une utilisation dans des carrosseries de voiture • Equipé de quatre roues qui permettent la circulation des véhicules soulevés • Dispositifs de sécurité avec cylindre hydraulique double et bloc de vannes • Blocage automatique des bras
-  Apto para taller • Con 4 ruedas pivotantes que permiten la movimentación de los vehículos planteadas • Seguridad hidráulica con doble cilindro y válvula de bloqueo • Bloqueo automático de brazos

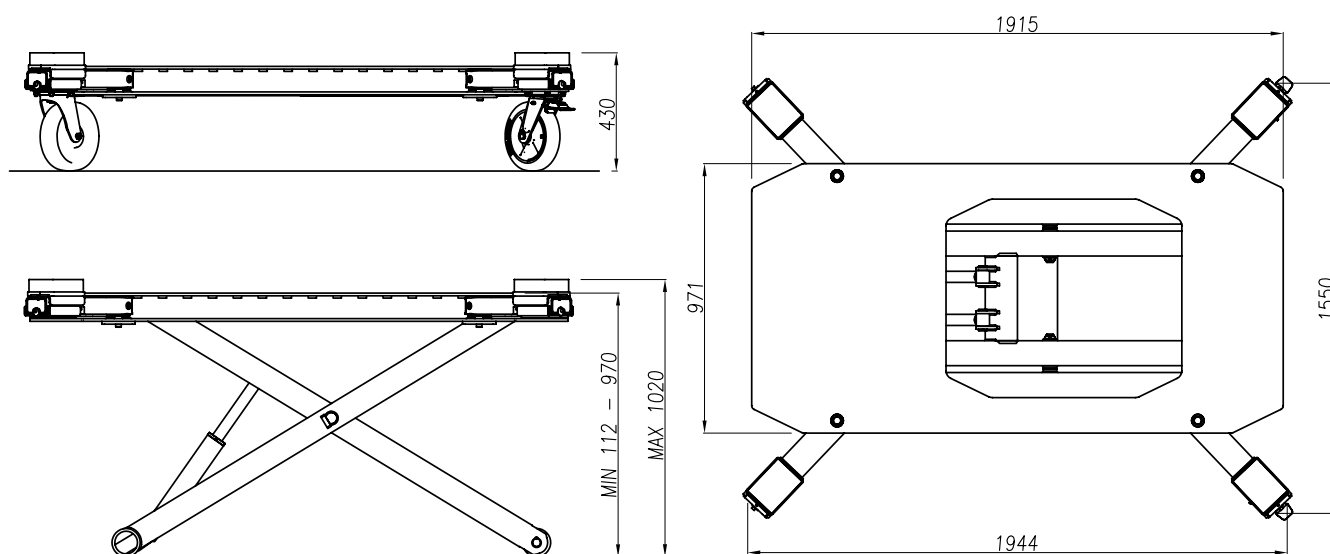

Dati tecnici



Technical data



Technische Eigenschaften



Caractéristiques techniques



Datos técnicos

Funzionamento • Operation • Funktionsweise • Fonctionnement • Funcionamiento	• Pneumo-idraulico • Hydropneumatic • Pneumatik-Hydraulik • Pneumo-hydraulique • Neumo-Hidráulico
Portata • Capacity • Tragfähigkeit • Capacité • Capacidad	3000 kg
Peso • Weight • Gewicht • Poids • Peso	400 kg
Salita/Discesa • Lifting/lowering • Hub/Senkzeit • Levage/descente • Subida/bajada	60/45 s
Pressione di servizio • Operating pressure • Betriebsdruck • Pression de service • Presión de servicio	8/10 bar

