











STRATOS SRM 3,2 t | SRE 3,5 t



-  Sollevatore idraulico a forbice a profilo super-ribassato
-  Extra-low-profile hydraulic scissor lift
-  Elektrohydraulische Scherenhebebühne mit extra-niedriger Überfahrhöhe
-  Pont à ciseaux super-surbaissé
-  Elevador hidráulico de tijera de perfil súper-bajo



-  Rampette di salita e discesa di facile movimentazione • Sincronismo idraulico delle pedane • Sicurezza idraulica in caso di sovraccarico • Sicurezza idraulica in caso di rottura dei tubi • Regolazione automatica della discesa • Comandi uomo presente, 24V • Serie 4 tamponi in gomma • Segnale acustico ultimo tratto di discesa
-  Easy to handle drive-on and drive-off ramps • Hydraulic synchronization of platforms • Overload safety-valve • Safety-valve in case of sudden loss of pressure • Automatic lowering control • "Dead man" controls 24V • Set of 4 rubber pads • 'Buzzer' on last portion of descent
-  Einfachste Bedienung der Auf- und Abfahrrampen • Hydraulische Gleichlaufregulierung der Fahrschienen • Überlastsicherung mittels Überdruckventil • Rohrbruchsicherung • Automatische Senkregulierung • Totmann-Steuerung (24 V-Niederspannung) • 4 Fahrzeugaufnahme-Gummiblöcke • Akustisches Signal im letzten Teil der Senkbewegung
-  Rampes de montée et descente • Synchronisation hydraulique des plateformes • Sécurité hydraulique en cas de surcharge • Sécurité hydraulique en cas de rupture de tuyauterie • Autorégulation de descente • Commandes de type "homme mort" à 24V • Jeux de 4 taquets en caoutchouc • Signal sonore sur la dernière partie de descente
-  Rampas de subida y bajada fáciles de desplazar • Sincronización hidráulica de las plataformas • Seguridad hidráulica contra sobrecarga • Seguridad hidráulica en caso de rotura tubos • Seguridad mecánica de cremallera • Regulación automática del descenso • Mandos de hombre presente, 24V • Juego de 4 tacos en goma • Señal acústica último tramo de descenso

STRATOS SRM 3,2 t

SRE 3,5 t

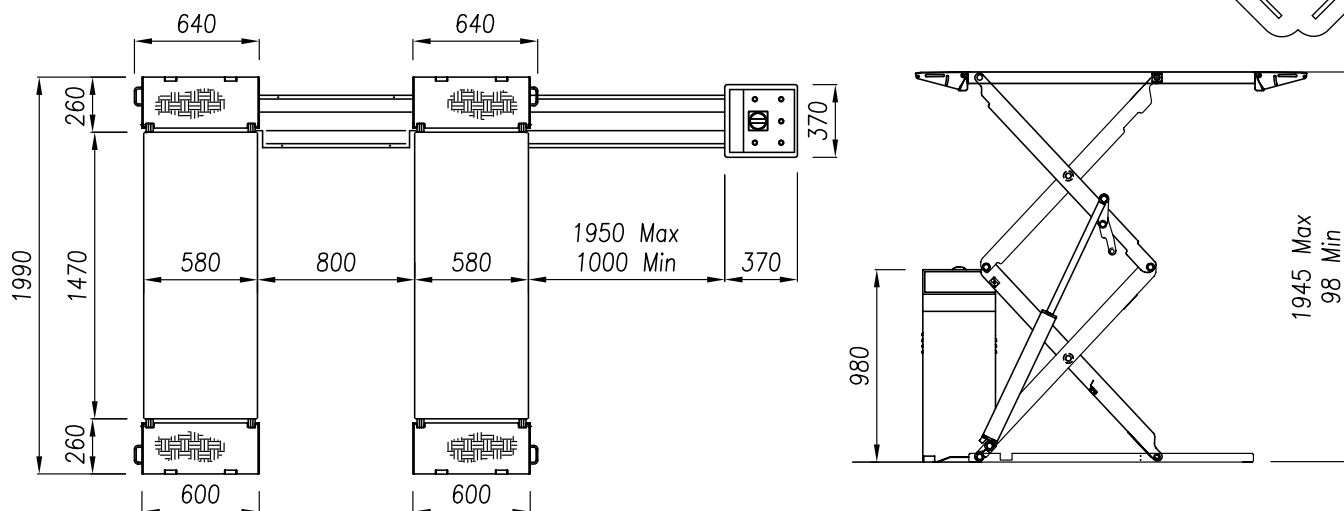

Dati tecnici

Technical data

Technische Eigenschaften

Caractéristiques techniques

Datos técnicos

	SRM	SRE
Funzionamento • Operation • Funktionsweise • Fonctionnement • Funcionamiento	Elettroidraulico • Electro-hydraulic • Elektrohydraulisch • Electrohydraulique • Electro-hidráulico	Elettroidraulico • Electro-hydraulic • Elektrohydraulisch • Electrohydraulique • Electro-hidráulico
Portata • Capacity • Tragfähigkeit • Capacité • Capacidad	3.200 kg	3.500 kg
Peso • Weight • Gewicht • Poids • Peso	730 kg	750 kg
Salita/Discesa • Lifting/lowering • Hub/Senkzeit • Levage/descente • Subida/bajada		35/40 s
Altezza di sollev. • Lifting height • Hubhöhe • Hauteur de levage • Altura de elevación		1945 mm
Motore • Motor • Motorleistung • Puissance moteur • Motor		2,2 kW - 230-400 V/50 Hz 3 ph

Installazione standard sopra pavimento • Altezza minima: 98 mm • Facile accesso anche con vetture ribassate

Surface mounted version as a standard • Minimal height: 98 mm • Easy to drive-over even with low cars

Aufbodenversion ist Standard • Mindesthöhe: 98 mm • Einfaches Überfahren auch mit tiefgelegten Fahrzeugen

Version installée sur sol est standard • Hauteur minimum: 98 mm • Accès très facile même avec voitures très basses

Instalación estándar sobre suelo • Altura mínima: 98 mm • Fácil acceso también con vehículos de perfil bajo



Doppio circuito idraulico di sicurezza • Coppia di cilindri volumetrici sotto ciascuna pedana

Double hydraulic system • Double volumetric cylinder under each platform

Zweifaches Hydrauliksystem • Doppelzylinder in jeder Schere

Système hydraulique double • Double vérin hydraulique sous chaque plateforme

Doble circuito hidráulico de seguridad • Pareja de cilindros volumétricos debajo de cada plataforma



Opzioni

Optionals

Sonderzubehör

Options

Opcionales

Prolonghe per tubi idraulici 2 m • Esecuzione monofase • Telaio per incasso • Kit scivoli per incasso • Rampe ausiliarie per vetture ribassate • Traverse per veicoli speciali

Hose extensions 2 m • Single phase version • Recess frame • Kit of embedded run-on and run-off skids • Auxiliary ramps for lowered cars • Cross-pieces for special vehicles

Schlauchverlängerungen 2 m • Einphasige Ausführung • Bodeneinbaurahmen • Satz Abrollrampen für Bodeneinbad • Zusatzrampen für tiefgelegte Fahrzeuge • Traversen für Sonderfahrzeuge

Rallonges pour tuyaux hydrauliques 2 m • Version monophasée • Cadre de montage en encastrement • Jeu de rampes de roulement pour encastrement • Rampes auxiliaires pour voitures surbaissées • Traverses pour véhicules spéciaux

Prolongaciones para tubos hidráulicos 2 m • Motor monofásico • Estructura para empotrar • Juego de rampas para empotrar • Rampas auxiliares para vehículos de perfil bajo • Travesaños para vehículos especiales