











-  Sollevatore idraulico a forbice a profilo ribassato
-  **Low-profile hydraulic scissor lift**
-  Elektrohydraulische Scherenhebebühne mit niedriger Überfahrhöhe
-  Pont à ciseaux surbaissé
-  Elevador hidráulico de tijera de perfil lbajo



-  Rampette di salita e discesa di facile movimentazione • Sincronismo idraulico delle pedane • Sicurezza idraulica in caso di sovraccarico • Sicurezza idraulica in caso di rottura dei tubi • Regolazione automatica della discesa • Comandi uomo presente, 24V • Serie 4 tamponi in gomma • Segnale acustico ultimo tratto di discesa
-  Easy to handle drive-on and drive-off ramps • Hydraulic synchronization of platforms • Overload safety-valve • Safetyvalve in case of sudden loss of pressure • Automatic lowering control • "Dead man" controls 24V • Set of 4 rubber pads • 'Buzzer' on last portion of descent
-  Einfache Bedienung der Auf- und Abfahrrampen • Hydraulische Gleichlaufregulierung der Fahrschienen • Überlastsicherung mittels Überdruckventil • Rohrbruchsicherung • Automatische Senkregulierung • Totmann-Steuerung (24 V-Niederspannung) • 4 Fahrzeugaufnahme-Gummielöcke • Akustisches Signal im letzten Teil der Senkbewegung
-  Rampes de montée et descente • Synchronisation hydraulique des plateformes • Sécurité hydraulique en cas de surcharge • Sécurité hydraulique en cas de rupture de tuyauterie • Autorégulation de descente • Commandes de type "homme mort" à 24V • Jeux de 4 taquets en caoutchouc • Signal sonore sur la dernière partie de descente
-  Rampas de subida y bajada fáciles de desplazar • Sincronización hidráulica de las plataformas • Seguridad hidráulica contra sobrecarga • Seguridad hidráulica en caso de rotura tubos • Seguridad mecánica de cremallera • Regulación automática del descenso • Mandos de hombre presente, 24V • Juego de 4 tacos en goma • Señal acústica último tramo de descenso

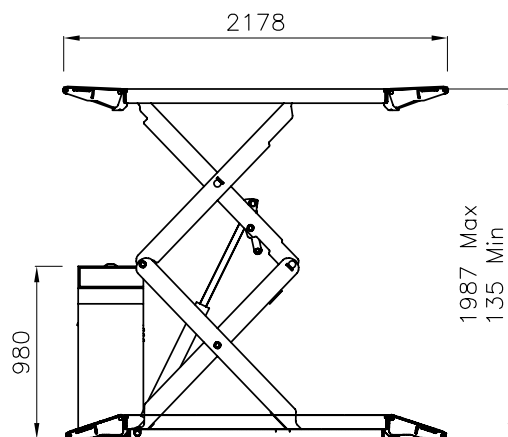
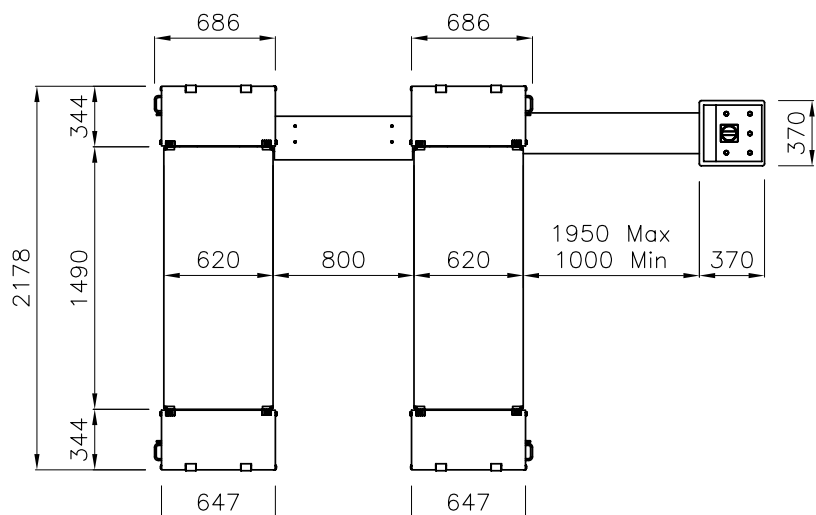

Dati tecnici

Technical data

Technische Eigenschaften

Caractéristiques techniques

Datos técnicos

Funzionamento • Operation • Funktionsweise • Fonctionnement • Funcionamiento	Elettroidraulico • Electro-hydraulic • Elektrohydraulisch • Électrohydraulique • Electro-hidráulico
Portata • Capacity • Tragfähigkeit • Capacité • Capacidad	4.000 kg
Peso • Weight • Gewicht • Poids • Peso	900 kg
Salita/Discesa • Lifting/lowering • Hub/Senkzeit • Levage/descente • Subida/bajada	40 s - 30 s
Altezza di sollev. • Lifting height • Hubhöhe • Hauteur de levage • Altura de elevación	1987 mm
Motore • Motor • Motorleistung • Puissance moteur • Motor	3 kW -230-400V/50Hz-3ph

Doppio circuito idraulico di sicurezza • Coppia di cilindri volumetrici sotto ciascuna pedana
Double hydraulic system • Double volumetric cylinder under each platform
 Doppelhydrauliksystem • Doppelzylinder in jeder Schere
 Système hydraulique double • Double vérin hydraulique sous chaque plateforme
 Doble circuito hidráulico de seguridad • Pareja de cilindros volumétricos debajo de cada plataforma



Opzioni

Optionals

Sonderzubehör

Options

Opcionales

Prolonghe per tubi idraulici 2 m • Rampe ausiliarie per vetture ribassate • Traverse per veicoli speciali
Hose extensions 2 m • Auxiliary ramps for lowered cars • Crosspieces for special vehicles
 Schlauchverlängerungen 2 m • Zusatzrampen für tiefergelegte Fahrzeuge • Traversen für Sonderfahrzeuge
 Rallonges pour tuyaux hydrauliques 2 m • Rampes auxiliaires pour voitures surbaissées • Traverses pour véhicules spéciaux
 Prolongaciones para tubos hidráulicos 2 m • Rampas auxiliares para vehículos de perfil bajo • Travesaños para vehículos especiales