











-  Ponte elettroidraulico a forbice di media altezza per gommisti e carrozzieri
-  Electro-hydraulic, mid-raise scissor lift for tyre and car body shops
-  Elektrohydraulischer Mittelhub-Scherenheber für Reifenservice und Karosserieshops
-  Pont électro-hydraulique basse levée pour spécialistes de pneus et carrosseries
-  Elevador electro-hidráulico de tijera, de mediana altura, para carrocerías y talleres de neumáticos



-  Rampette di salita e discesa di facile movimentazione • Parallelismo idraulico e sincronismo delle pedane • Sicurezza idraulica in caso di sovraccarico • Sicurezza idraulica in caso di rottura dei tubi • Regolazione automatica della discesa • Comandi uomo presente, 24V • Serie 4 tamponi in gomma • Comando di sicurezza ultimo tratto di discesa • Segnale acustico ultimo tratto di discesa
-  Easy to handle drive-on and drive-off ramps • Hydraulically synchronized platforms • Overload safety-valve • Safety-valve in case of sudden loss of pressure • Automatic lowering control • "Dead man" controls 24V • Set of 4 rubber pads • Safety control on last descent segment • 'Buzzer' on last portion of descent
-  Einfachste Bedienung der Auf- und Abfahrampen • Hydraulische Gleichlaufregulierung der Fahrschienen • Überlastsicherung mittels Überdruckventil • Rohrbruchsicherung • Automatische Senkregulierung • Totmann-Steuerung (24 V-Niederspannung) • 4 Fahrzeugaufnahme-Gummiblöcke • Sicherheitsantrieb auf letztem Abstiegsabschnitt • Akustisches Signal im letzten Teil der Senkbewegung
-  Rampes de montée et descente • Parallélisme hydraulique et synchronisme des plateformes de levage • Sécurité hydraulique en cas de surcharge • Sécurité hydraulique en cas de rupture de tuyauterie • Autorégulation de descente • Commandes de type "homme mort" à 24V • Jeux de 4 taquets en caoutchouc • Commande de sécurité fin descente • Signal sonore sur la dernière partie de descente
-  Rampas de elevación/descenso fáciles de desplazar • Paralelismo hidráulico y sincronismo de las plataformas • Seguridad hidráulica contra la sobrecarga • Seguridad hidráulica contra la rotura de tubos • Regulación automática del descenso • Mandos de hombre presente, 24V • Serie de 4 tacos de goma • Mando de seguridad último tramo de descenso • Señal acústica último tramo de descenso

263 3,0 t

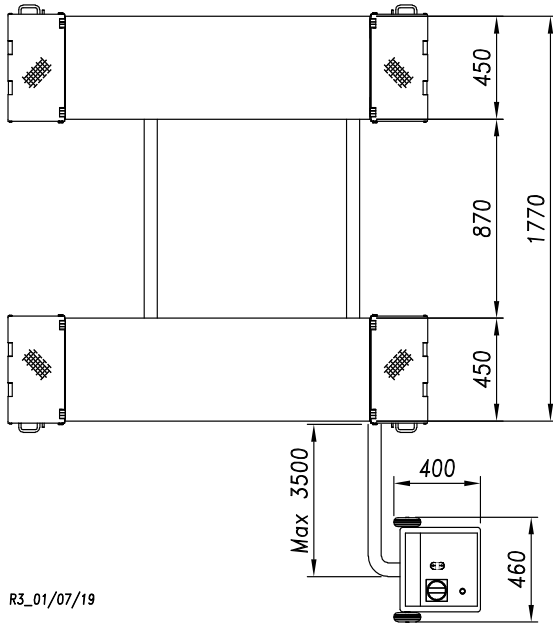

R3_01/07/19

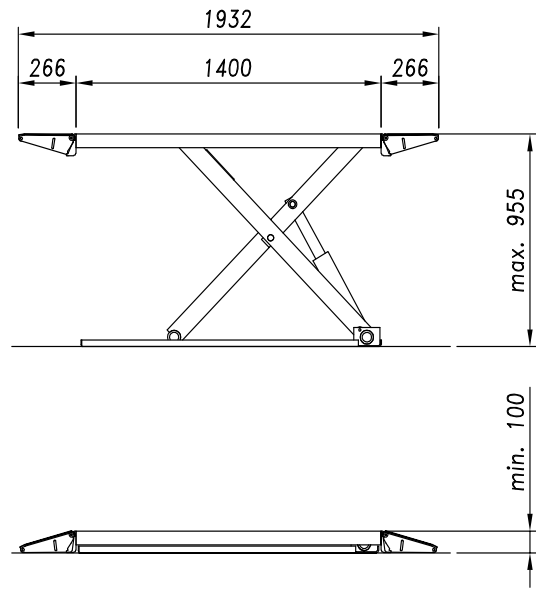

Dati tecnici	Technical data	Technische Eigenschaften	Caractéristiques techniques	Datos técnicos	
Portata	Capacity	Tragfähigkeit	Capacité	Capacidad	3000 kg
Peso	Weight	Gewicht	Poids	Peso	470 kg
Salita/Discesa	Lifting/lowering	Hub/Senkzeit	Levage/descente	Subida/bajada	30 s / 35 s
Altezza di sollevamento	Lifting height	Hubhöhe	Hauteur de levage	Altura de elevación	955 mm
Motore	Motor	Motorleistung	Puissance moteur	Motor	1,1 kW -400V/50Hz



Doppio circuito idraulico indipendente.
Distributore di flusso in centralina

Double hydraulic circuit system with flow distributor.

Zweifaches, getrenntes Hydraulik-Hubsystem.
Wegeventil an der Hydraulikeinheit im Steuerkasten.

Système hydraulique double et séparé.
Déviateur hydraulique placé sur la centrale hydraulique dans le pupitre de commande.

Doble circuito hidráulico y cada independiente.
Distribuidor de flujo situado en la unidad de mando.



ALTEZZA MINIMA: 100 mm
Facile accesso anche con vetture ribassate

MINIMAL HEIGHT: 100 mm
Easy to drive-over even with low cars

MINDESTHÖHE: 100 mm
Einfaches Überfahren auch mit tiefgelegten Fahrzeugen

HAUTEUR MINIMUM: 100 mm
Accès très facile même avec voitures très basses

ALTURA MÍNIMA: 100 mm
Acceso facilitado también con vehículos de perfil bajo



Opzioni	Optionals	Sonderzubehör	Options	Opcionales
---------	-----------	---------------	---------	------------



Kit ruote trasporto
Set of wheels
Satz Hilfsräd
Chariot de déplacement
Kit ruedas transporte

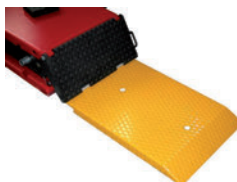

Rampe ausiliarie
Auxiliary drive on-/drive-off ramps
Zusatzrampen
Rampes auxiliaires de monté/descente
Rampas auxiliares

Kit scivoli per incasso
Kit of embedded run-on and run-off skids
Satz Abrollrampen für Bodeneinbad
Jeu de rampes de roulement pour encastrement
Juego de rampas para empotrar