





402M 1,6 t | 402P 1,6 t



-  Traverse idrauliche
-  Hydraulic jacking beams
-  Hydraulische Achsfreiheber
-  Traverses hydrauliques
-  Travesaños hidráulicos



Modelli disponibili

Available versions

Lieferbare Ausführungen r Versions Disponibles

Versiones disponibles

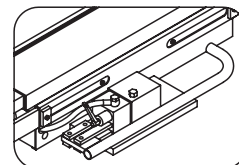
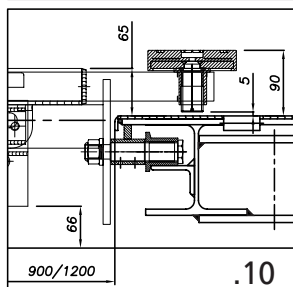
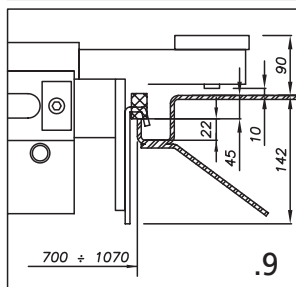
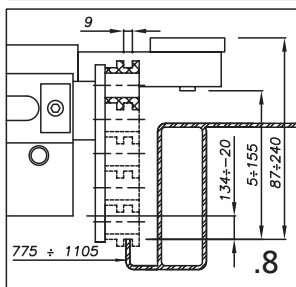
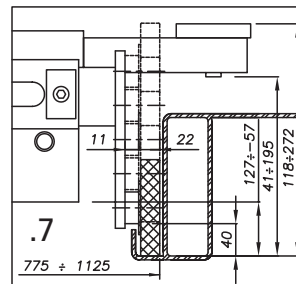
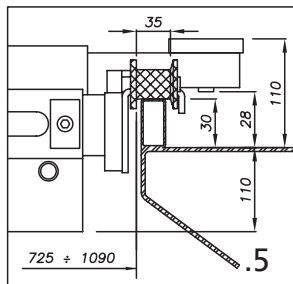
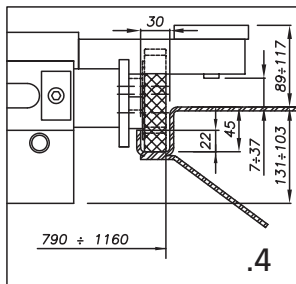
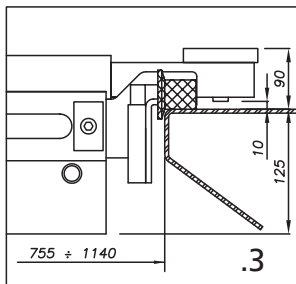

Pompa manuale
Pompe manuelle
Manual pump
Handpumpe

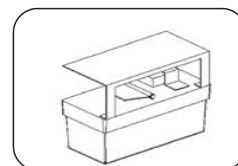

Pompa pneumatica
Pompe pneumatique
Pneumatic pump
Pneumatischer Pumpe

 Rullo/Galet/Roller/Rolle

 Sollevatore/Pont élévateur/Lift/Säulen

402M 1,6 t | 402P 1,6 t

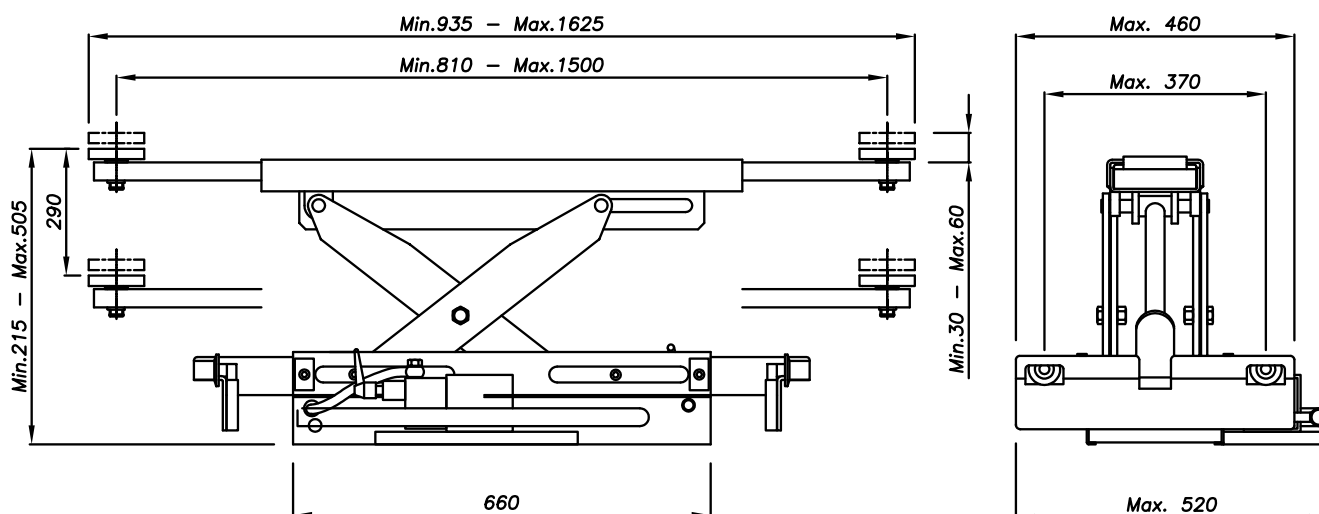

Dati tecnici	Technical data	Technische Eigenschaften	Caractéristiques techniques	Datos técnicos	
Portata	Capacity	Tragfähigkeit	Capacité	Capacidad	1.600 kg
Spostamento vert. del carico	Lifting height	Hubhöhe	Hauteur de levée	Desplazamiento vert. de la carga	290 mm
Estensione min (bracci chiusi)	Min extension (arms retracted)	Min. Aufnahmebreite (Arme voll eingefahren)	Extension min. des bras (bras rentrés)	Extensión mín. (brazos cerrados)	935 mm
Estensione max. (bracci aperti)	Max. extension (arms extracted)	Max. Aufnahmebreite (Arme voll ausgefahren)	Extension max des bras (bras sortis)	Extensión máx. (brazos abiertos)	1.625 mm
Scartamento delle ruote di scorrimento	Gauge	Spurweite	Ecartement des roulettes	Ancho de via	vedere dettagli schemi - please refer to carriage diagram
Peso della traversa	Weight	Gewicht	Poids	Peso del travesaño	105 kg



Opzioni	Optionals	Sonderzubehör	Options	Opcionales
---------	-----------	---------------	---------	------------



L1166

Kit appoggi per traversa
Support kit for jacking beam
Stützesatz für Achsfreiheber
Jeu de supports pour traverse
Kit soportes para travesaños



L1198-60 mm
L1277-100 mm

Estensioni per tamponi di sollevamento
Lifting pad extensions
Hubspindelverlängerungen
Rallonges pour tampons de levage
Extensiones para tacos de elevación