











496M 2,0 t | 496P 2,0 t



-  Traverse idrauliche
-  Hydraulic jacking beams
-  Hydraulische Achsfreiheber
-  Traverses hydrauliques
-  Travesaños hidráulicos



				
Modelli disponibili	Available versions	Lieferbare Ausführungen	Versions Disponibles	Versiones disponibles

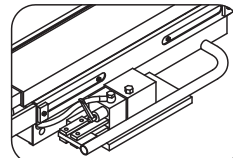
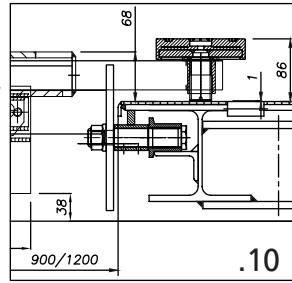
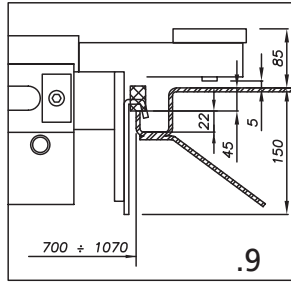
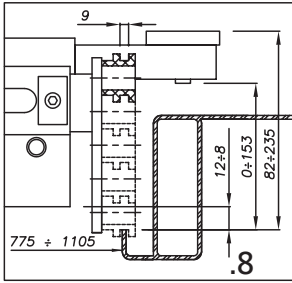
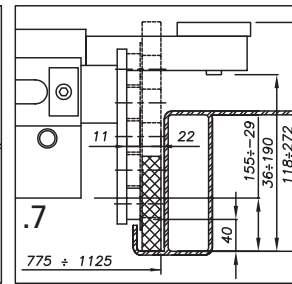
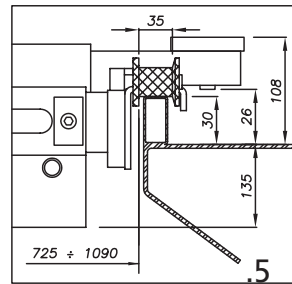
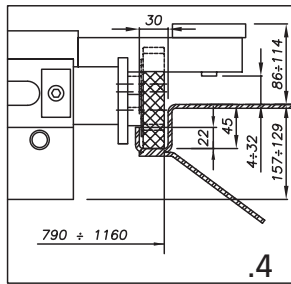
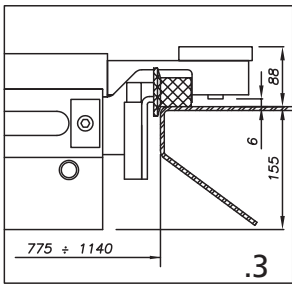

Pompa manuale
Pompe manuelle
Manual pump
Handpumpe

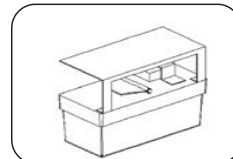







Pompa pneumatica
Pompe pneumatique
Pneumatic pump
Pneumatischer Pumpe

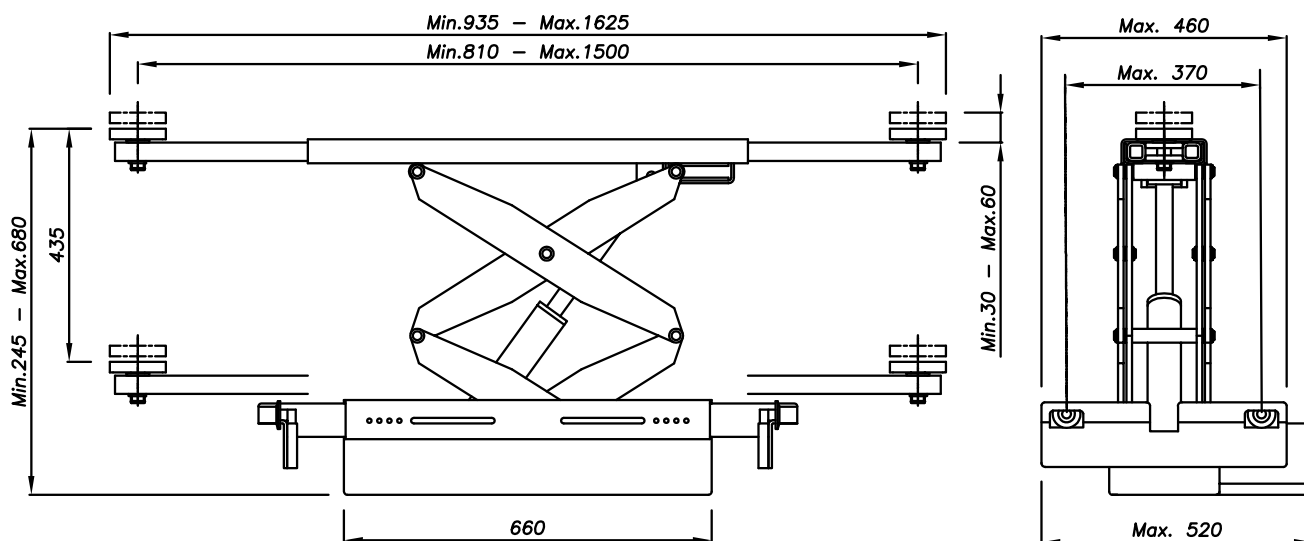



 Rullo/Galet/Roller/Rolle

 Sollevatore/Pont élévateur/Lift/Säulen

496M 2,0 t | 496P 2,0 t



 Dati tecnici	 Technical data	 Technische Eigenschaften	 Caractéristiques techniques	 Datos técnicos	
Portata	Capacity	Tragfähigkeit	Capacité	Capacidad	2.000 kg
Spostamento vert. del carico	Lifting height	Hubhöhe	Hauteur de levée	Desplazamiento vert. de la carga	435 mm
Estensione min (bracci chiusi)	Min extension (arms retracted)	Min.Aufnahmebreite (Arme voll eingefahren)	Extension min. des bras (bras rentrés)	Extensión mín. (brazos cerrados)	935 mm
Estensione max.(bracci aperti)	Max. extension (arms extracted)	Max. Aufnahmebreite (Arme voll ausgefahren)	Extension max des bras (bras sortis)	Extensión máx. (brazos abiertos)	1.625 mm
Scartamento delle ruote di scorrimento	Gauge	Spurweite	Ecartement des roulettes	Ancho de via	vedere dettagli schemi - please refer to carriage diagram
Peso della traversa	Weight	Gewicht	Poids	Peso del travesaño	135 kg

 Opzioni	 Optionals	 Sonderzubehör	 Options	 Opcionales
--	---	---	---	--



L1166

Kit appoggi per traversa
Support kit for jacking beam
Stützesatz für Achsfreiheber
Jeu de supports pour traverse
Kit soportes para travesaños



L1198-60 mm
L1277 100 mm

Estensioni per tamponi di sollevamento
Lifting pad extensions
Hubspindelverlängerungen
Rallonges pour tampons de levage
Extensiones para tacos de elevación