











# ECOLIFT 3,5 t



-  Sollevatore elettroidraulico per isole di bonifica
-  Electro-hydraulic single post lift for vehicle depollution systems
-  Elektrohydraulische Einsäulen-Hebebühne für Fahrzeug-Trockenlegungsstationen
-  Pont monocolonne électrohydraulique pour la dépollution de véhicules
-  Elevador electro-hidráulico para la demolición y recuperación de residuos peligrosos



-  Sollevatore multiuso in particolare per utilizzo nelle Isole di Bonifica • Piastre predisposte su colonna per inserimento bracci di lavoro (optional) • Dispositivo elettromeccanico di sicurezza • Sicurezza idraulica in caso di sovraccarico • Valvola controllo discesa • Comandi uomo presente 24V
-  Multipurpose hydraulic single post lift specially conceived for vehicle de-pollution systems • On the post there are special holders for arms that bear extraction probes and funnels (arms are delivered as an option) • Electromechanical locking device • Overload safety-device • Descent control valve • Dead man controls 24V
-  Hydraulische Mehrzweck-Hebebühne für Sonderanwendungen in der Fahrzeug-Trockenlegung und Entsorgung • Halter für Gelenkarme für Bohrspitzen und Aufnahmetrichter (Soderzubehör) • Summer für letzten Teil der Senkbewegung • Überlastsicherung • Senkventil • Totmann-Schaltung 24V
-  Pont élévateur monocolonne hydraulique multi-usage conçu pour la dépollution véhicules • Plaques de support pour les bras articulés de travail avec les perforateurs et les entonnoirs (bras articulés sont en option) • Dispositif électromécanique de sécurité • Sécurité hydraulique en cas de surcharge • Vanne contrôle descente • Commandes de type "homme mort" 24V
-  Elevador polivalente apto para talleres de demolición y recuperación de residuos peligrosos • Placas en las columna aptas para inserir brazos para trabajar (optional) • Dispositivo de seguridad • Seguridad hidráulica contra sobrecargas • Válvula de control descenso • Mandos de hombre presente, 24V

# ECOLIFT 3,5 t

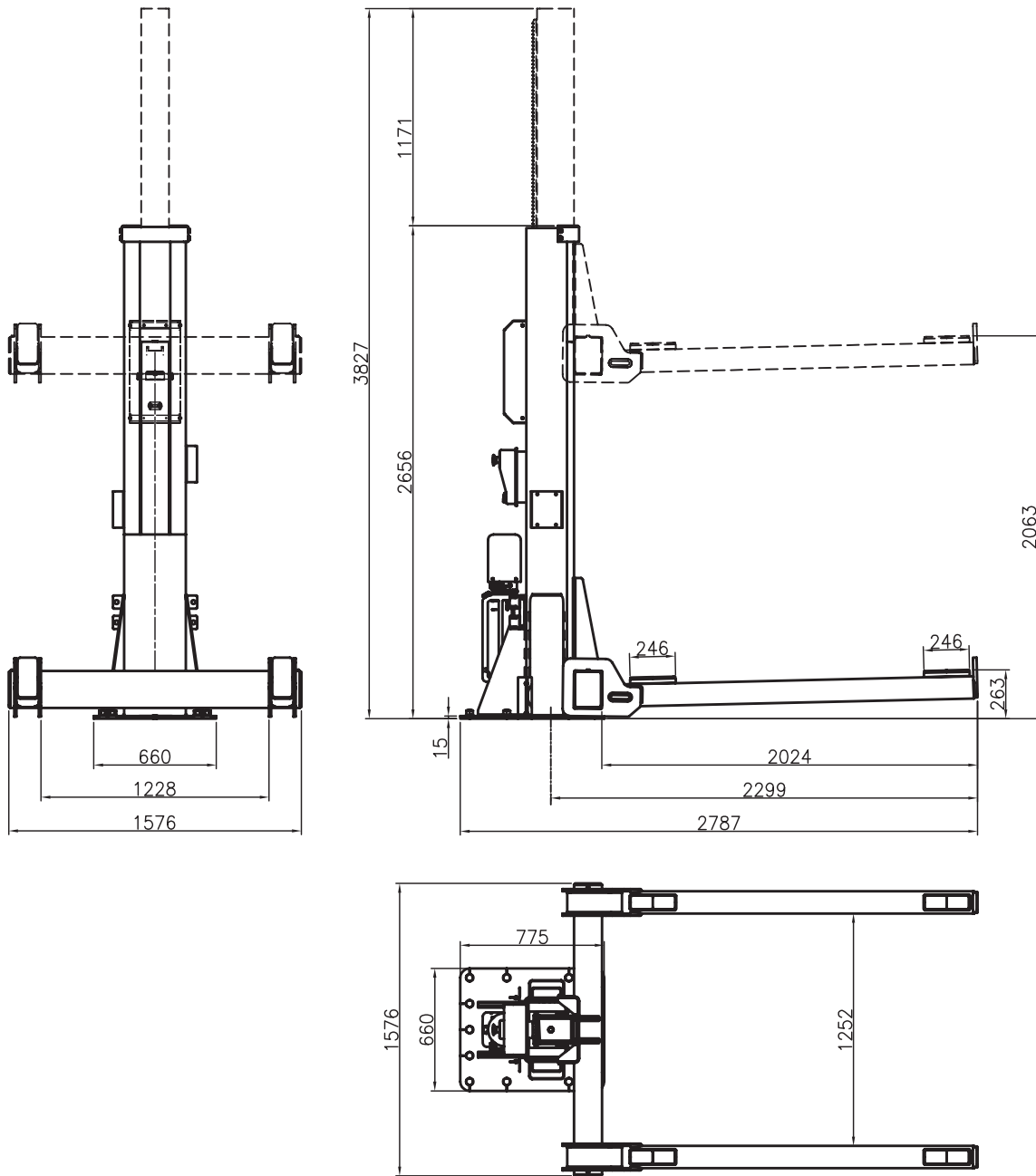

Dati tecnici	Technical data	Technische Eigenschaften	Caractéristiques techniques	Datos técnicos	
Portata	Capacity	Tragfähigkeit	Capacité	Capacidad	3.500 kg
Peso	Weight	Gewicht	Poids	Peso	600 kg
Salita/Discesa	Lifting/lowering	Hub/Senkzeit	Levage/descente	Subida/bajada	60/45 s
Altezza di sollevamento	Lifting height	Hubhöhe	Hauteur de levage	Altura de elevación	2063 mm
Altezza minima	Min. height	Mindesthöhe	Hauteur min.	Altura minima	290 mm
Motore	Motor	Motorleistung	Puissance moteur	Motor	2,2 kW - 3 ph 230-400V/50 Hz