



W107 - W107SE - W107LP - W107SE/LPG - W108 W108SE - W108LP - W108SE/LPG

500-1000 kg



 Gru idrauliche pieghevoli

 Hydraulic folding cranes

 Hydraulischer, klappbarer Kran

 Grues hydrauliques pliable

 Grúas hidráulica plegable



LP

- LP = Ribassato
- **LP = Low profile**
- LP = Tiefgesetzt
- LP = Surbaisse
- LP = Perfil bajo

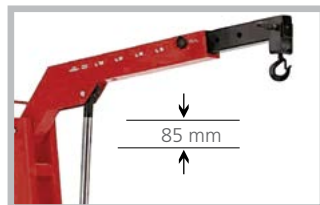

SE

- SE = Semplice effetto
- **SE = Single action pump**
- SE = Einfachwirkende Pumpe
- SE = Pompe simple effet
- SE = Acción simple

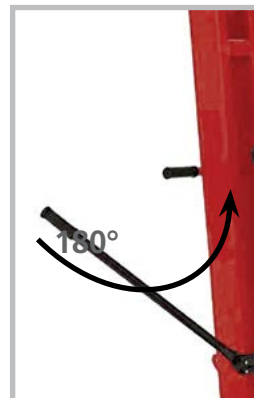

G

- G = Pompa pivotante
- **G = Pivoting pump**
- G = Drehbar gelagerte Pumpe
- G = Pompe pivotante
- G = Bomba pivotante

 Valvola limitatrice di carico • Comando tipo uomo presente • Comando di discesa proporzionale • Stelo cromato

 **Overload safety-valve • Feet guards • Proportional lowering control • Chromium plated rod**

 Überlastventil • Totmann-Senksteuerung • Proportionale Senksteuerung • Verchromte Kolbenstange

 Sécurité hydraulique en cas de surcharge • Commande de type "homme mort" • Commande de descente proportionnelle • Tige chromée

 Válvula limitadora de carga • Mando de tipo hombre presente • Mando de descenso proporcional • Vástago cromado

W107 - W107SE - W107LP - W107SE/LPG - W108 W108SE - W108LP - W108SE/LPG

500-1000 kg



	SE		LP		G	
Modello	Con pompa a semplice effetto	Con pompa a doppio effetto	Basso profilo (gambe)	Pompa pivotante	Portata	
Model	With single action pump	With double action pump	Low profile (legs)	Pivoting pump	Capacity	
Modell	Mit einfachwirkender Pumpe	Mit doppeltwirkender Pumpe	Niedrige Bauhöhe (Beine)	Drehbar gelagerte Pumpe	Tragkraft	
Modèle	Avec pompe simple effect	Avec pompe double effect	Profil surbaissé (pieds)	Pompe pivotante	Capacité	
Modelo	Con bomba de acción simple	Con bomba de doble acción	Perfil bajo (patas)	Bomba pivotante	Capacidad de carga	
W107		X				500 Kg
W107SE	X					500 Kg
W107LP		X	X			500 Kg
W107SE/LP G	X		X	X		500 Kg
W108		X				1000 Kg
W108SE	X					1000 Kg
W108LP		X	X			1000 Kg
W108SE/LP G	X		X	X		1000 Kg



Dati tecnici

Technical data

Technische Eigenschaften

Caractéristiques techniques

Datos técnicos

	W107 W107SE	W108 W108SE	W107LP W107SE/LPG	W108LP W108SE/LPG
A	1600	1650	1580	1595
B	1540	1560	1490	1505
C	1200	1380	1200	1380
D	900	1080	900	1080
E	140	165	85	85
F	330	470	385	480
H	1940	2220	1875	2185
I	2070	2400	2005	2390
L	720	835	700	760
M	885	1000	905	1010
N	440	550	450	550
kg	80	110	85	118

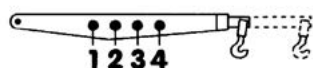
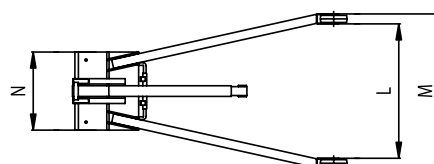
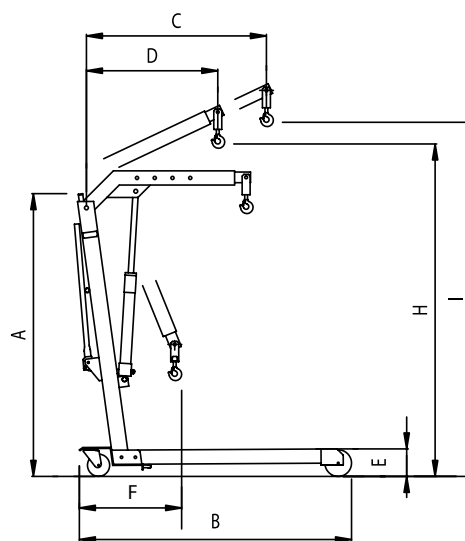

Kg				
1	500	1000	500	1000
2	400	800	400	800
3	350	650	350	650
4	250	450	250	450